

Acer Monitor KB242HYL

# LIFECYCLE EXTENSION GUIDE

---

# Contents

## Table of Contents

<b>Important Safety Notice</b> .....	<b>3</b>
<b>1. Exploded Diagram</b> .....	<b>4</b>
<b>2. Wiring connectivity diagram</b> .....	<b>5</b>
<b>3. Mechanical Instruction</b> .....	<b>6</b>
<b>4. Disassembly and Assembly SOP</b> .....	<b>7</b>
<b>5. Troubleshooting</b> .....	<b>12</b>
<b>6. FRU List</b> .....	<b>14</b>

### Safety Notice

Any person attempting to service this chassis must familiarize with the chassis and be aware of the necessary safety precautions to be used when serving electronic equipment containing high voltage

## Important Safety Notice

### Product Announcement:

This product is certificated to meet RoHS Directive and Lead-Free produced definition. Using approved critical components only is recommended when the situation to replace defective parts. Vender assumes no liability express or implied, arising out of any unauthorized modification of design or replacing non-RoHS parts. Service providers assume all liability.

### Qualified Repairability:

Proper service and repair is important to the safe, reliable operation of all series products. The service providers recommended by vender should being aware of notices listed in this service manual in order to minimize the risk of personal injury when perform service procedures. Furthermore, the possible existed improper repairing method may damage equipment or products. It is recommended that service engineers should have repairing knowledge, experience, as well as appropriate product training per new model before performing the service procedures.

### NOTICE:

! To avoid electrical shocks, the products should be connect to an authorized power cord, and turn off the master power switch each time before removing the AC power cord.

! To prevent the product away from water or explosed in extremely high humility environment.

! To ensure the continued reliability of this product, use only original manufacturer's specified parts.

! To ensure following safety repairing behavior, put the replaced part on the components side of PWBA, not solder side.

! To ensure using a proper screwdriver, follow the torque and force listed in assembly and disassembly procedures to screw and unscrew screws.

! Using Lead-Free solder to well mounted the parts.

! The fusion point of Lead-Free solder requested in the degree of 220°C.

## 1. Exploded Diagram

### 1.1 Product Exploded Diagram

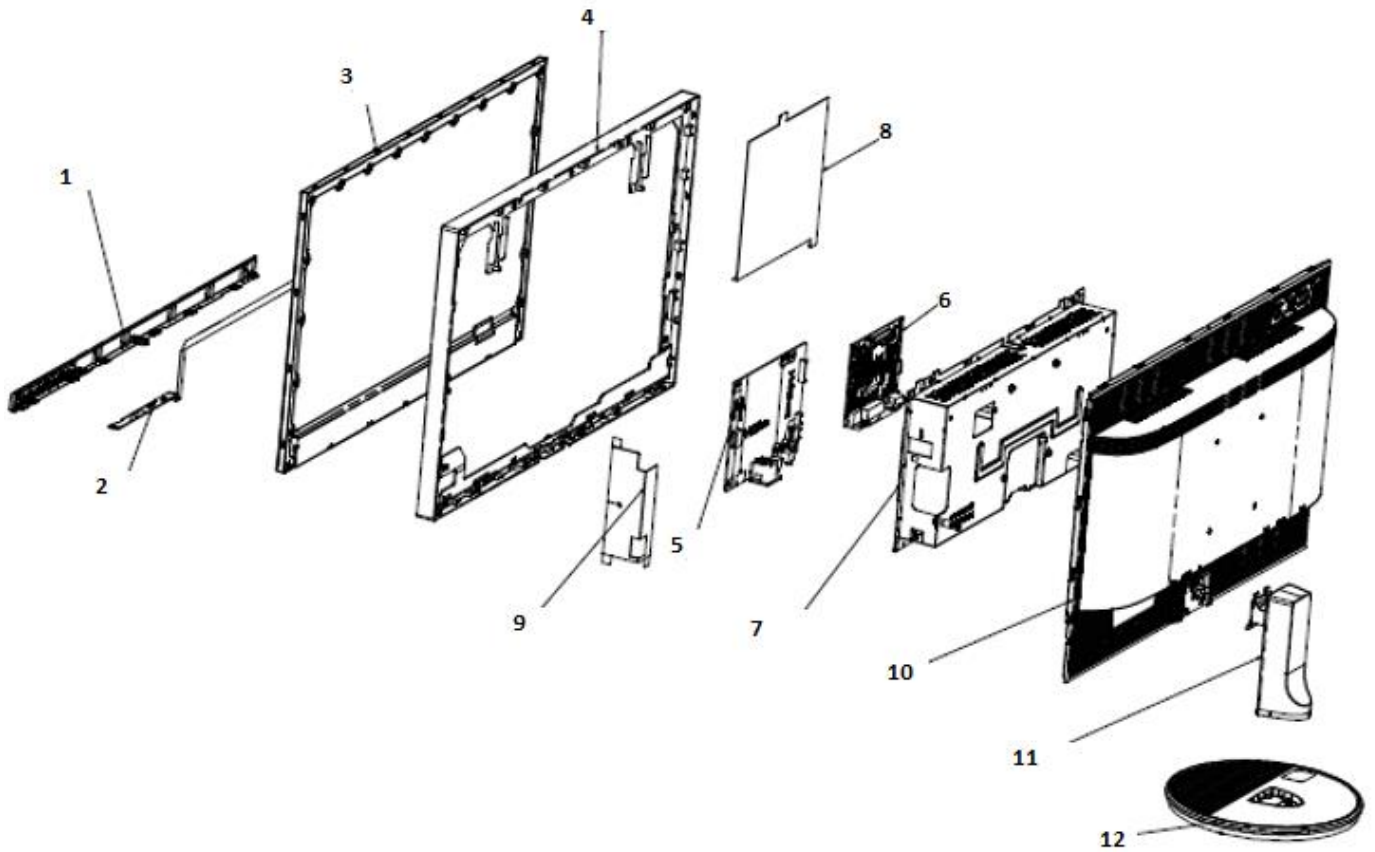

INDEX	DESCRIPTION
1	ASSY TRIM K272HL
2	PCBA CTRL BD
3	LCDM 27W AUO M270HVN02.3Q0 Z
4	MID-FRAME
5	PCBA SPS BD
6	PCBA IF BD
7	ASSY SHD
8	MYLAR
9	MYLAR
10	ASSY RC
11	ASSY CLMN
12	ASSY BASE

## 2. Wiring connectivity diagram

There are four types of wiring diagrams for model KB242HYL. The wiring connectivity position will be different according to the ACTUAL PCBA connector position. Please base on different SKU refer to below diagram.

NOTE: INF BD= Interface Board, PWR BD=Power Board, CTRL BD= Control Board

### 1. SKU with USB

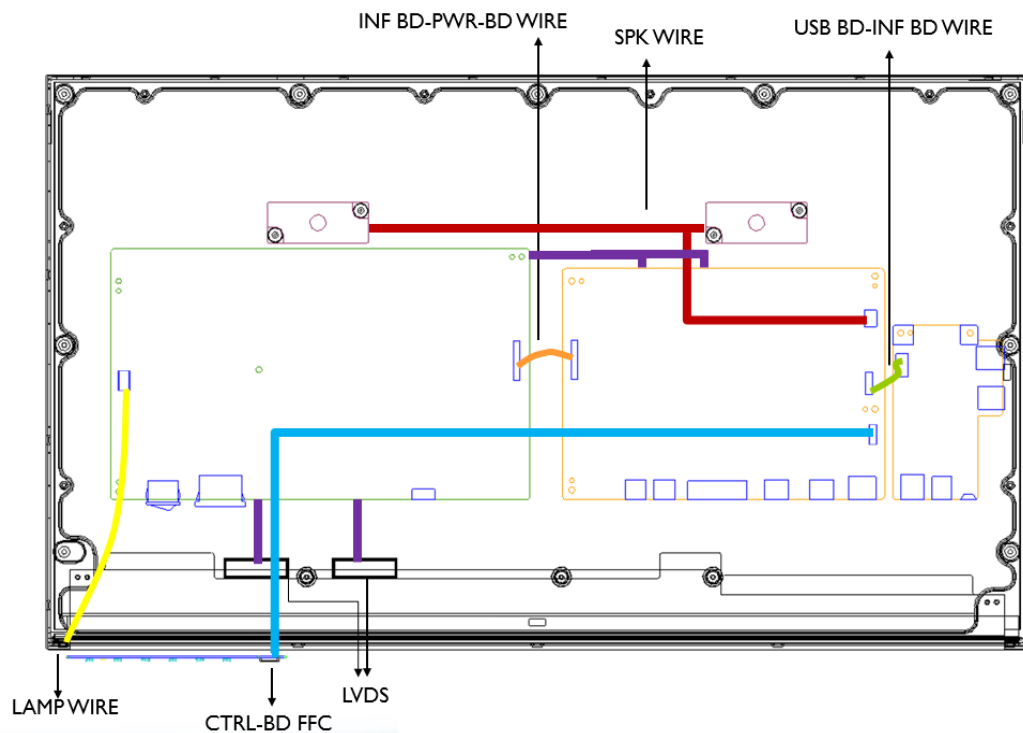

### 2. SKU without USB

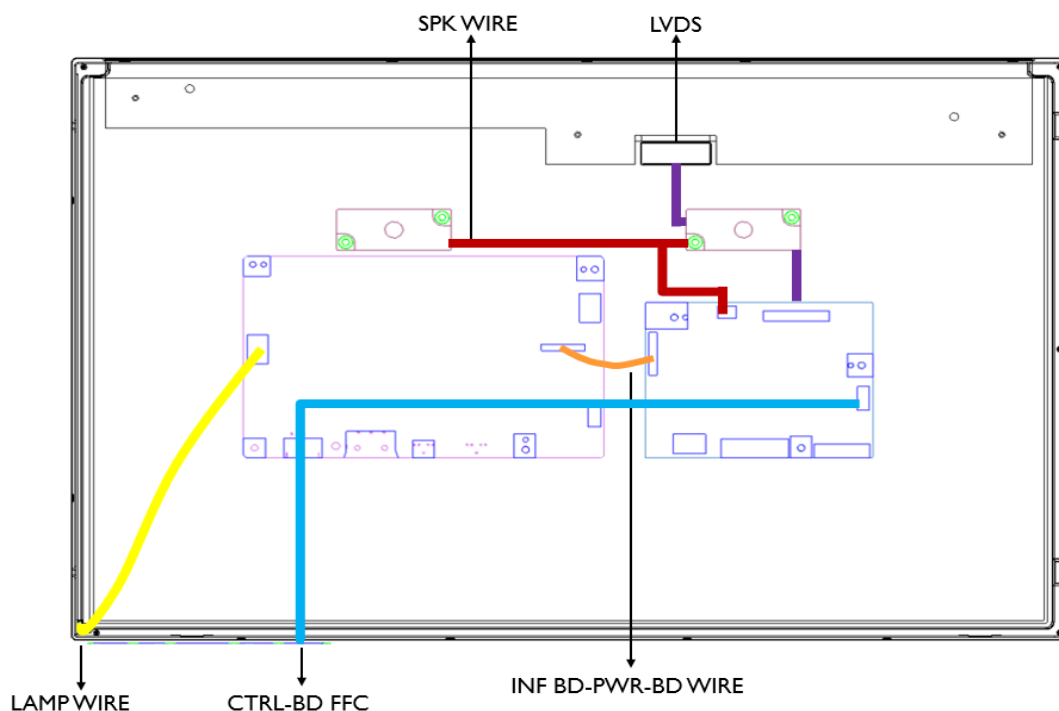

## Mechanical Instruction

### Tools Required

List the type and size of the tools that would typically can be used to disassemble the product to a point

where components and materials requiring selective treatment can be removed.

### Tool Description:

- working table
- Screw-driver: Philips-head screwdriver, Hex-head screwdriver
- Knife
- glove
- cleaning cloth
- ESD protection

## 4. Disassembly and Assembly SOP

### KB242HYL

#### 4.1 Disassembly Procedures

##### Preparation before disassemble

1. Clean the room for disassemble
2. Identify the area for monitor
3. Check the position that the monitors be placed and the quantity of the monitor ;prepare the area for material flow; according to the actual condition plan the disassemble layout
4. Prepare the implement, equipment, materials as bellow:
  - 1) working table
  - 2) Screw-driver: Philips-head screwdriver, Hex-head screwdriver
  - 3) knife
  - 4) glove
  - 5) cleaning cloth
  - 6) ESD protection



After unplugging the power cord, the power board still have power energe. Please pay attention when disassembling/assembling Power BD.

#### S1

Disassemble the RC(Rear Case), stand and base

Before Disassembling & Assembling, monitor need to be put on the sponge and the Insulation glove must be wore during the process.

Disassemble Stand and Base from the RC(Rear Case). Unlock RC screws. Disassemble RC from monitor.

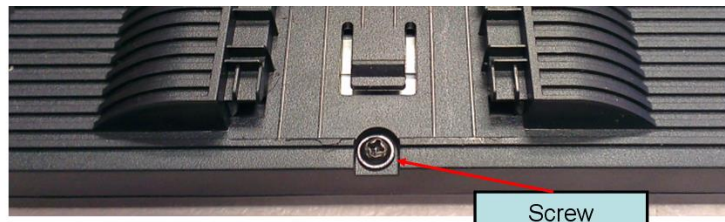
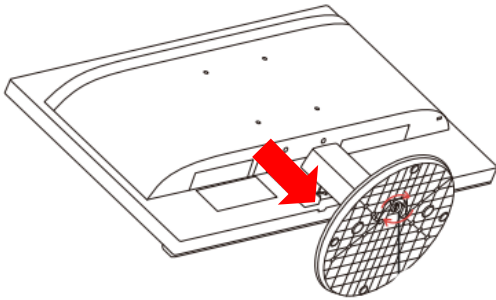

#### S2

Disassemble SHD





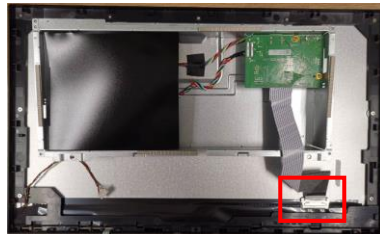

Extract CTRL FFC from IF BD as picture 1.  
Remove SHD from MF and extract FFC from panel as picture 2.

PICTURE 1

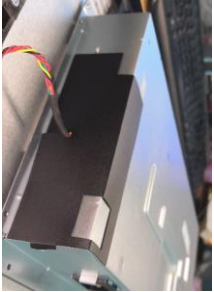
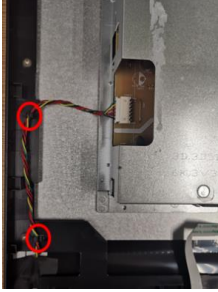

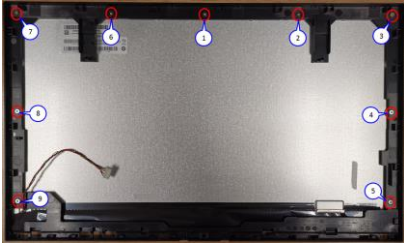
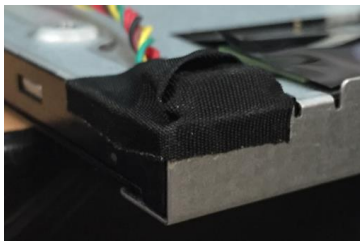
PICTURE 2

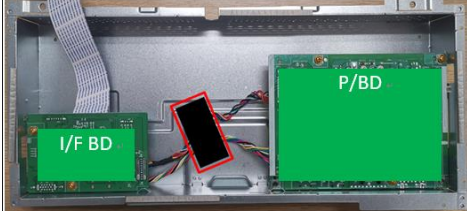

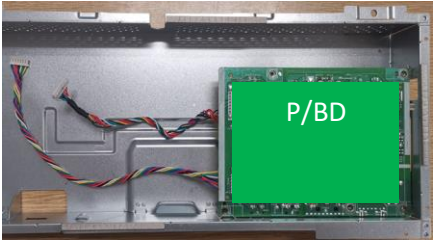
<p><b>S3</b> Disassemble the lamp wire</p>	<p>Tear down MYLAR off SHD(Shielding) as picture 1. Tear off the tape on the lamp wire and extract the lamp wire from the P/BD(Power Board) as picture 2.</p>	
<p>PICTURE 1</p> 	<p>PICTURE 2</p> 	
<p><b>S4</b> Disassemble the TRIM from MF.</p>	<p>Unlock 2 TRIM screws and disassemble TRIM from MF as picture 1. Disassemble CTRL BD from TRIM as picture 2.</p>	
<p>PICTURE 1</p> 	<p>PICTURE 2</p> 	
<p><b>S5</b> Disassemble MF and lamp wire from panel.</p>	<p>Unlock 9 screws from MF and disassemble MF from panel as picture 1. Tear off adhesive tape from panel as picture 2. Extract lamp wire from panel as picture 3.</p>	
<p>PICTURE 1</p> 	<p>PICTURE 2</p> 	<p>PICTURE 3</p> 
<p><b>S6</b> Disassemble I/F BD and P/BD from SHD.</p>	<p>Disassembled the Mylar and adhesive tape from SHD. Unlock 2 hex screws and all PCBA screws as picture 2. Disassemble the I/F BD from the SHD and extract the P/BD wire, FFC LVDS. Disassemble the P/BD from the SHD.</p>	
<p>PICTURE 1</p> 	<p>PICTURE 2</p> 	<p>PICTURE 3</p> 



**NOTE:** Circuit boards >10 cm<sup>2</sup> has been highlighted with the yellow rectangle as above image shows. Please detach the Circuit boards and follow local regulations for disposal.



## 4.2 Assembly Procedures

## Preparation before assemble:

1. Clean the room for work
2. Identify the area for material
3. Prepare the implement, equipment, materials as bellow:

- 1) working table
- 2) Screw-driver
- 3) Knife
- 4) glove
- 5) cleaning cloth
- 6) ESD protection



After unplugging the power cord, the power board still have power energy. Please pay attention when disassembling/assembling Power BD.

**S1**

## Assemble I/F BD and P/BD

Before Disassembling & Assembling, monitor need to be put on the sponge and the Insulation glove must be wore during the process.

Insert the audio wire to P/BD as picture 1.

Insert the FFC, audio wire and P/BD wire to the I/F as picture 2.

Stick 1 tape on the SHD remarked with red frame, lock all screws and put Mylar on the Power BD as picture3.

PICTURE 1

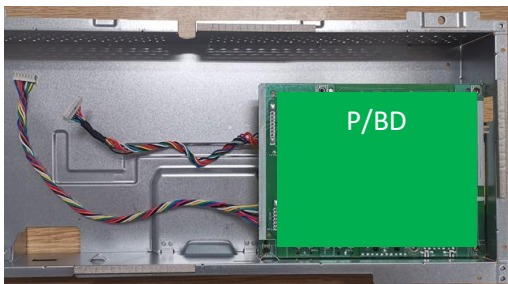

PICTURE 2

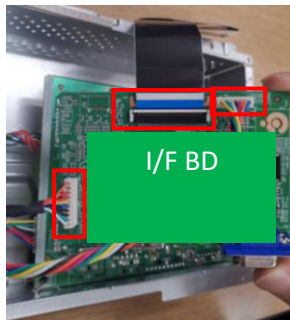

PICTURE 3

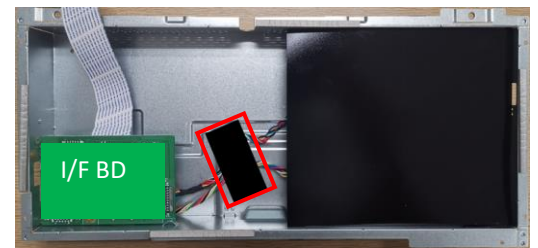
**S2**

## Assemble MF and Panel

Take the Panel, insert lamp wire and stick 1 piece of adhesive tape as picture 1.





Assemble the MF to the panel ,and lock 9 screws to the MF as picture2.

PICTURE 1

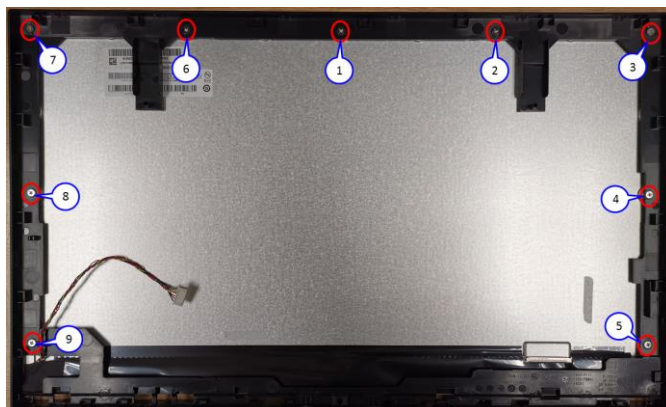

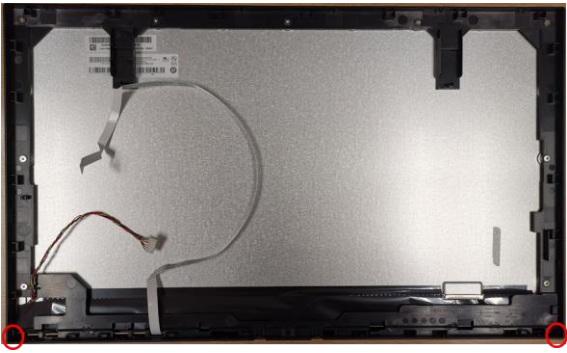
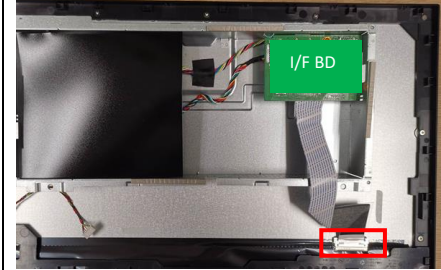
PICTURE 2

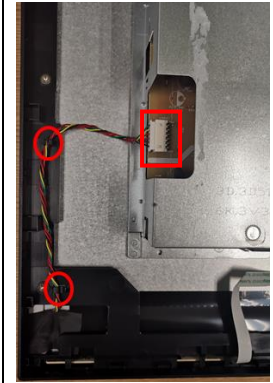

<p><b>S3</b> Assemble CTRL BD</p>	<p>Assemble CTRL BD to TRIM as picture 1. Assemble TRIM to MF and lock 2 TRIM screws as picture 2.</p>	
<p>PICTURE 1</p> 	<p>PICTURE 2</p> 	
<p><b>S4</b> Assemble SHD</p>	<p>Insert FFC to the panel as picture 1. Locate SHD on MF as picture 2. Arrange CTRL FFC on panel and insert to IF BD as picture 3.</p>	
<p>PICTURE 1</p> 	<p>PICTURE 2</p> 	<p>PICTURE 3</p> 
<p><b>S5</b> Assemble the lamp wire</p>	<p>Arrange lamp wire and insert to P/BD as picture 1. Stick 1 Mylar to SHD as picture 2.</p>	
<p>PICTURE 1</p> 	<p>PICTURE 2</p> 	

**S6**

Assemble RC, stand and base

Assemble the RC with screw as picture 1.

Assembly the Stand and the Base to Monitor as picture 2.

PICTURE 1

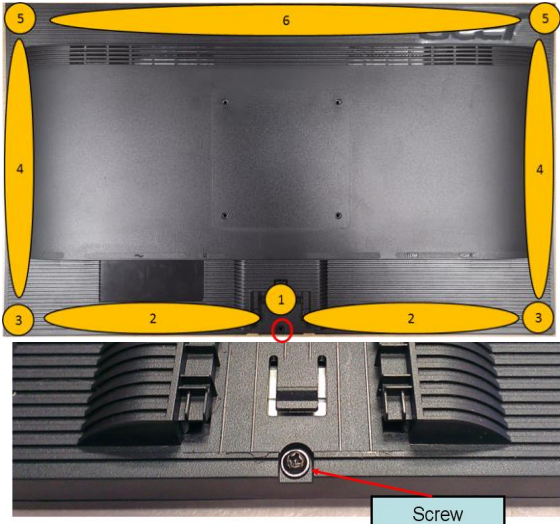

PICTURE 2



NOTE: Circuit boards >10 cm<sup>2</sup> has been highlighted with the yellow rectangle as above image shows. Please detach the Circuit boards and follow local regulations for disposal.

## 5. Troubleshooting

### TROUBLESHOOTING

Before sending your LCD monitor for servicing, please check the trouble-shooting list below to see if you can self-diagnose the problem.

(VGA Mode)

Problems	Current Status	Remedy
No Picture	LED ON	<ul style="list-style-type: none"> <li>Using OSD, adjust brightness and contrast to maximum or reset to their default settings.</li> </ul>
	LED OFF	<ul style="list-style-type: none"> <li>Check the power switch.</li> </ul>
		<ul style="list-style-type: none"> <li>Check if AC power cord is properly connected to the monitor.</li> </ul>
	LED displays amber color	<ul style="list-style-type: none"> <li>Check if video signal cable is properly connected at the back of monitor.</li> </ul>
<ul style="list-style-type: none"> <li>Check if the power of computer system is ON.</li> </ul>		
Abnormal Picture	Unstable Picture	<ul style="list-style-type: none"> <li>Check if the specification of graphics adapter and monitor is in compliance which may be causing the input signal frequency mismatch.</li> </ul>
	Display is missing, center shift, or too small or too large in display size	<ul style="list-style-type: none"> <li>Using OSD, adjust RESOLUTION, CLOCK, CLOCK-PHASE, H-POSITION and V-POSITION with non-standard signals.</li> <li>Using OSD, in case of missing full-screen image, please select other resolution or other vertical refresh timing.</li> <li>Using OSD, in case of missing full-screen image, please select other resolution or other vertical refresh timing.</li> <li>Wait for a few seconds after adjusting the size of the image before changing or disconnecting the signal cable or powering OFF the monitor.</li> </ul>
Abnormal Sound (Only Audio-Input model) (Optional)	No sound, or sound level is too low	<ul style="list-style-type: none"> <li>Check the audio cable with the host PC is connected.</li> </ul>
		<ul style="list-style-type: none"> <li>Check if the volume setup of the host PC is in minimum position and try to raise the volume level.</li> </ul>

## (HDMI/DP Mode)





Problems	Current Status	Remedy
No Picture	LED ON	<ul style="list-style-type: none"> <li>Using OSD, adjust brightness and contrast to maximum or reset to their default settings.</li> </ul>
	LED OFF	<ul style="list-style-type: none"> <li>Check the power switch.</li> </ul>
		<ul style="list-style-type: none"> <li>Check if AC power cord is properly connected to the monitor.</li> </ul>
	LED displays amber color	<ul style="list-style-type: none"> <li>Check if video signal cable is properly connected at the back of monitor.</li> </ul>
<ul style="list-style-type: none"> <li>Check if the power of computer system is ON.</li> </ul>		
Abnormal Sound (Only Audio-Input model) (Optional)	No sound, or sound level is too low	<ul style="list-style-type: none"> <li>Check the audio cable with the host PC is connected.</li> </ul>
		<ul style="list-style-type: none"> <li>Check if the volume setup of the host PC is in minimum position and try to raise the volume level.</li> </ul>

## 6. FRU List

This chapter gives you the FRU (Field Replaceable Unit) listing in global configurations of ACER KB242HYL. Refer to this chapter whenever ordering for parts to repair or for RMA (Return Merchandise Authorization).

Please note that WHEN ORDERING FRU PARTS, you should check the most up-to-date information available on your regional web or channel. For whatever reasons a part number change is made, it will not be noted on the printed Service Guide. For AUTHORIZED SERVICE PROVIDERS, your office may have a DIFFERENT part number code from those given in the FRU list of this printed Service Guide. You MUST use the local FRU list provided by your regional office to order FRU parts for repair and service of customer machines

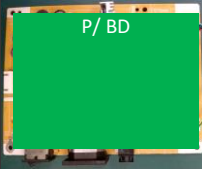
NOTE: To scrap or to return the defective parts, you should follow the local government ordinance or regulations on how to dispose it properly, or follow the rules set by your regional office on how to return it.

Category	ACER DESCRIPTION	Description	PART NO.
<b>LCD</b>			
	LED LCD Panel AUO 23.8' FHD None Glare M238HVN01.1Q0-Z19 250nit 3000:1 16ms	LCDM23.8 M238HVN01.1Q0 Z/G AUO	KL.23805.008
<b>BOARD</b>			
	MAIN BOARD 1A1H	PCBA IF BD MI KB242HYL AH	55.TM1M3.001
	POWER BOARD 1A1H	PCBA SPS BD MI K242 Q0 AH+AO	55.TM1M3.002
	FUNCTION KEY BOARD W/ WIRE	PCBA CTRL BD MI KB242HYL	55.TM1M3.003